



FLEXIBLE SPRINKLER DROPS

Technical Data

- ◆ Temperature : 225°F
- ◆ Pressure : 175 psi
- ◆ Connection : Inlet : 1" NPT
Outlet : 1/2" or 3/4" NPT
- ◆ Maximum Bend Radius : 4", 8"
(Do not bend within 2.52 inches from connection nuts)
- ◆ Maximum Number of Bend : Refer to Friction Loss Data
- ◆ K-Factor : 1/2" Outlet : 5.6 gpm
3/4" Outlet : 8.0 gpm

Features

Tube

- ◆ Lengths: 24", 36", 48", 60", 72"
- ◆ Outlet Reducer Diameter 3/8", 1/2", 3/4", 1" Straight or 90° Elbow
- ◆ Type: Braided 
- Unbraided 

Brackets

- ◆ TBS System:
T-bar Grid Commercial Suspend Ceiling
- ◆ MSB, HCB System:
Metal Stud/Sheetrock Suspend Ceiling

Optional

- ◆ Special lengths available on request

Friction Loss Data

Length	Outlet Connection	Maximum Number of 90° Bend	Equivalent Length of 1 in. Schedule 40 pipe, ft
24"	1/2"	1	6.8/18
24"	3/4"	1	4.7/18
36"	1/2"	2	11.5/31
36"	3/4"	2	10.6/34
48"	1/2"	3	16.7/48
48"	3/4"	3	12.7/51
60"	1/2"	4	20.6/60
60"	3/4"	4	17.0/65
72"	1/2"	4	24.0/71
72"	3/4"	4	19.8/72

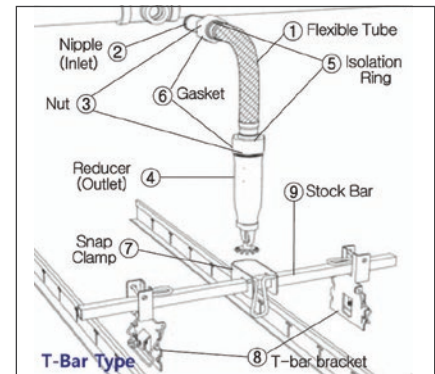
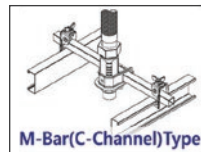
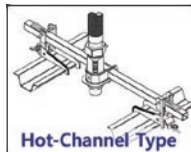
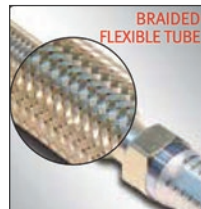

Commercial Type



Exhaust Ducts Type

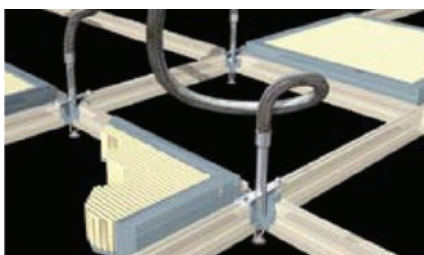

Cleanroom Type

